



M2M WIRELESS, VIDEO & BROADCOM SOLUTIONS

An Overview of cdma2000 Technology Concepts

Isidro Martinez

Director, Latin América

An Overview of cdma2000 Technology Concepts

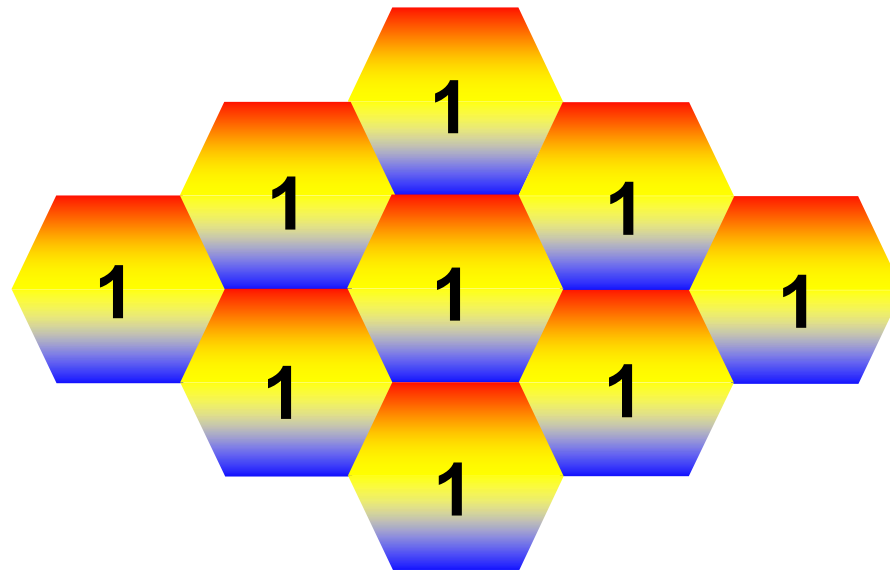

Contents

- Review of IS-95 CDMA Concepts
- cdma2000 Improvements
- cdma2000 Concepts
- cdma2000 Network Architecture

Cellular Access Methods

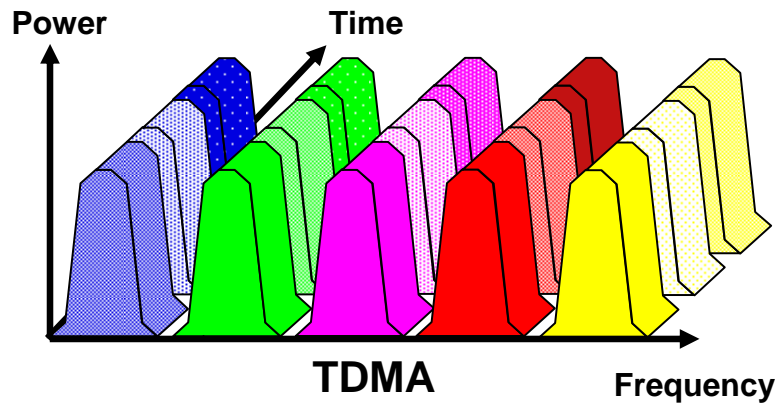
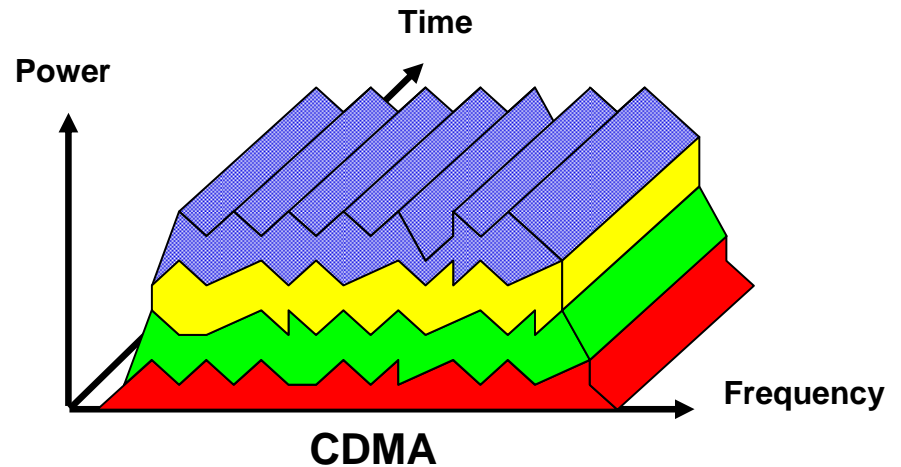
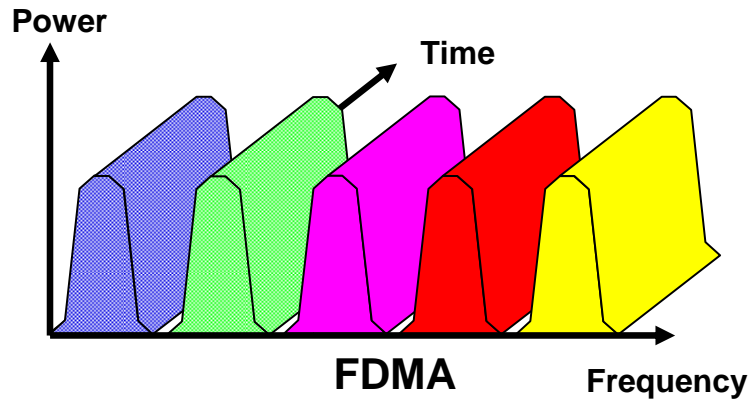

CDMA is Also Full Duplex

US Cellular Channel 384

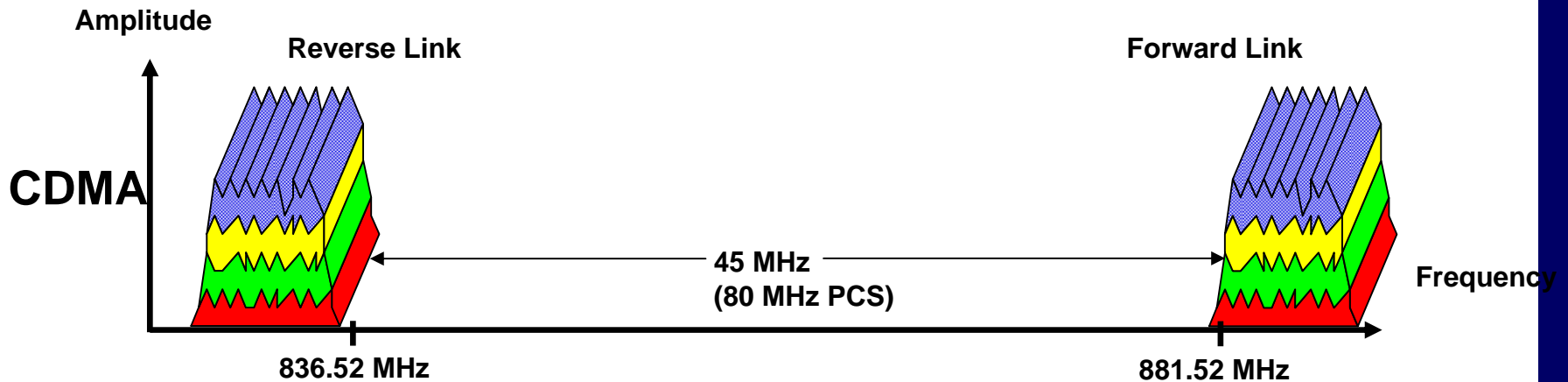
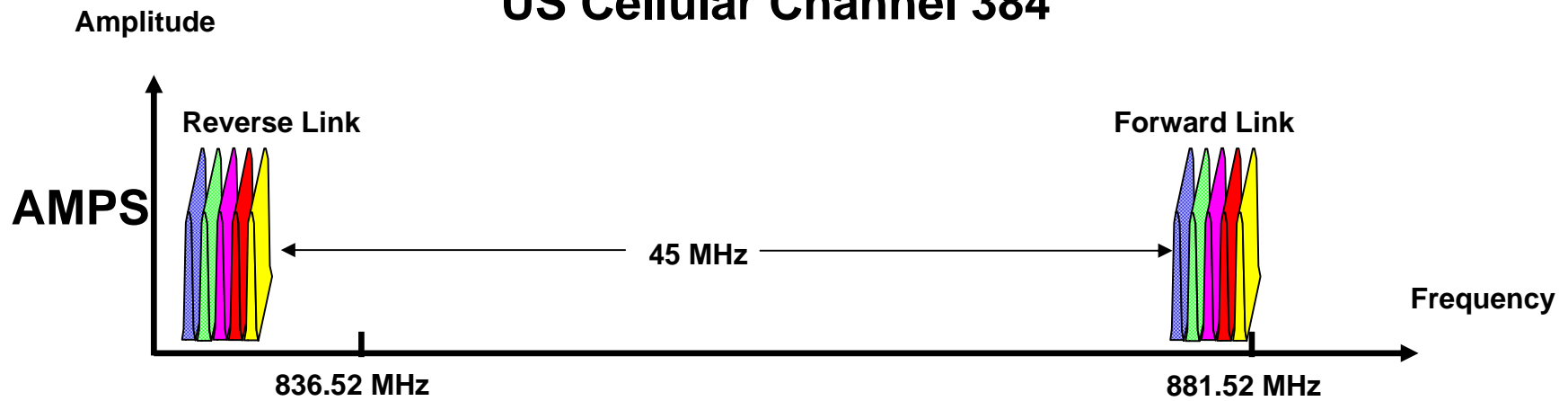

Cellular Frequency Reuse Patterns

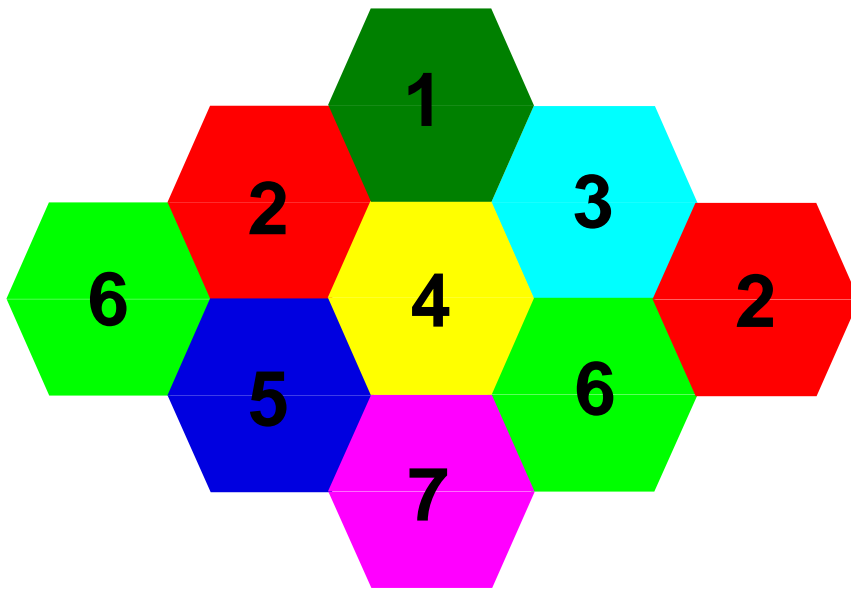

FDMA Reuse

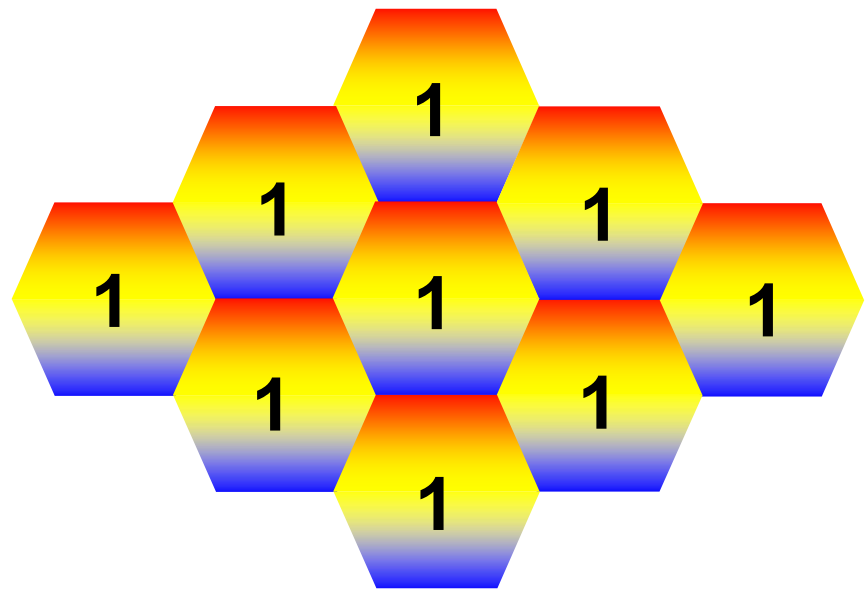

CDMA Reuse

The CDMA Concept

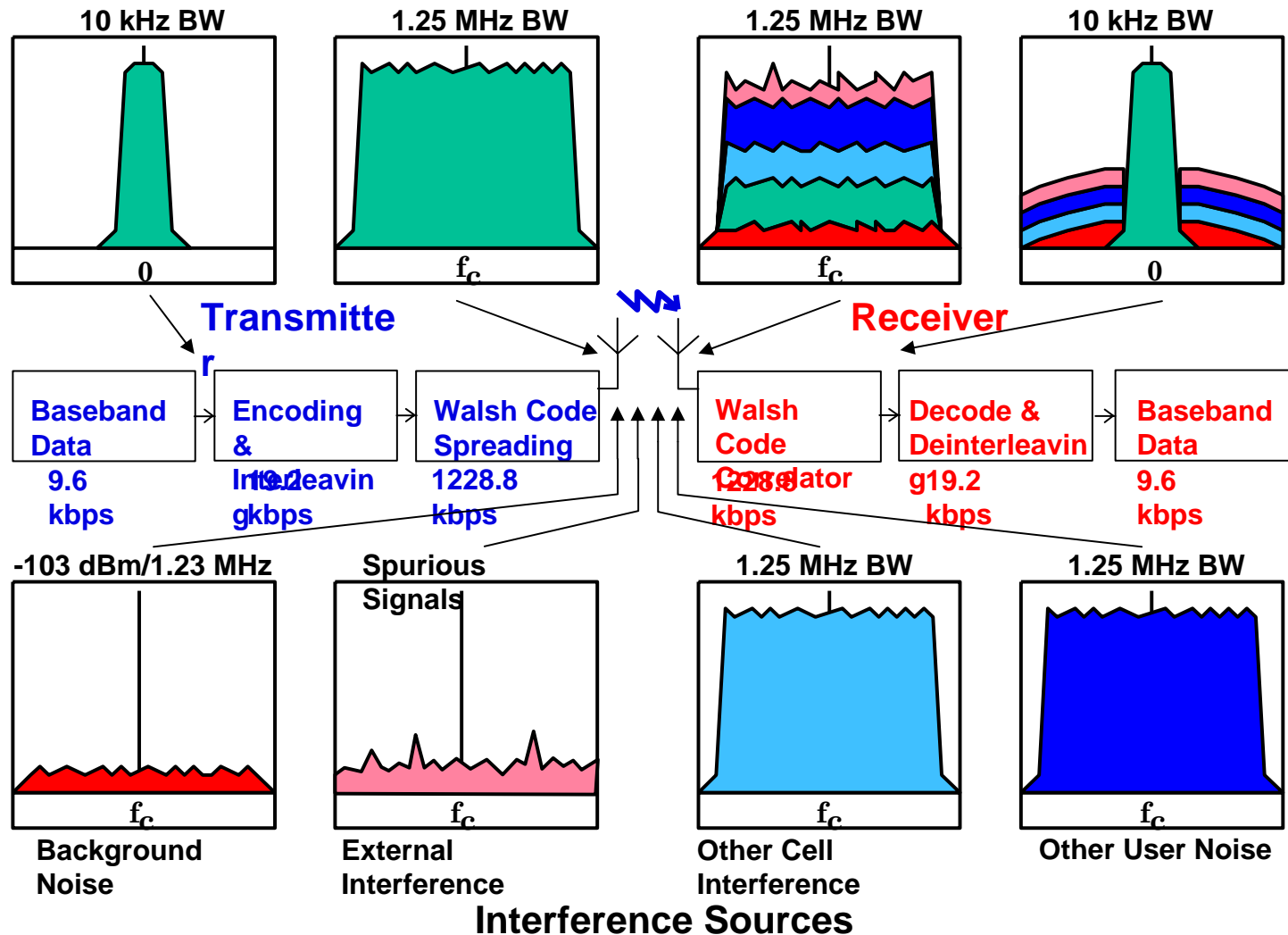

IS-2000 Terms and definitions

- **Chip**
 - Is the period of a data bit at the final spreading rate
- **SR - Spreading Rate**
 - Defines the final spreading rate in terms of 1.2288 Mcps.
- **RC - Radio Configuration**
 - Defines the physical channel configuration based upon a base channel data rate.
 - RCs contain rates derived from their base rate. For example, RC3 is based on 9.6 kbps and includes 9.6, 19.2, 38.4, 76.8, and 153.6 kbps.

What is Correlation?

- Is a Measure of How Well a Given Signal Matches a Desired Code
- The Desired Code is Compared to the Given Signal at Various Test Times

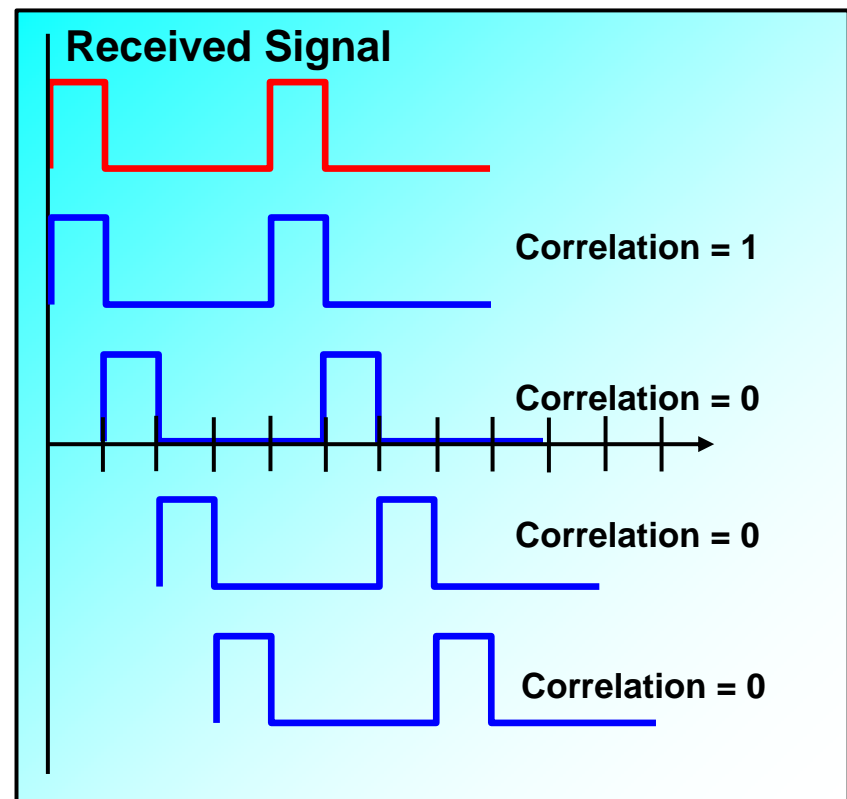

Spatial Diversity During Soft Handoff

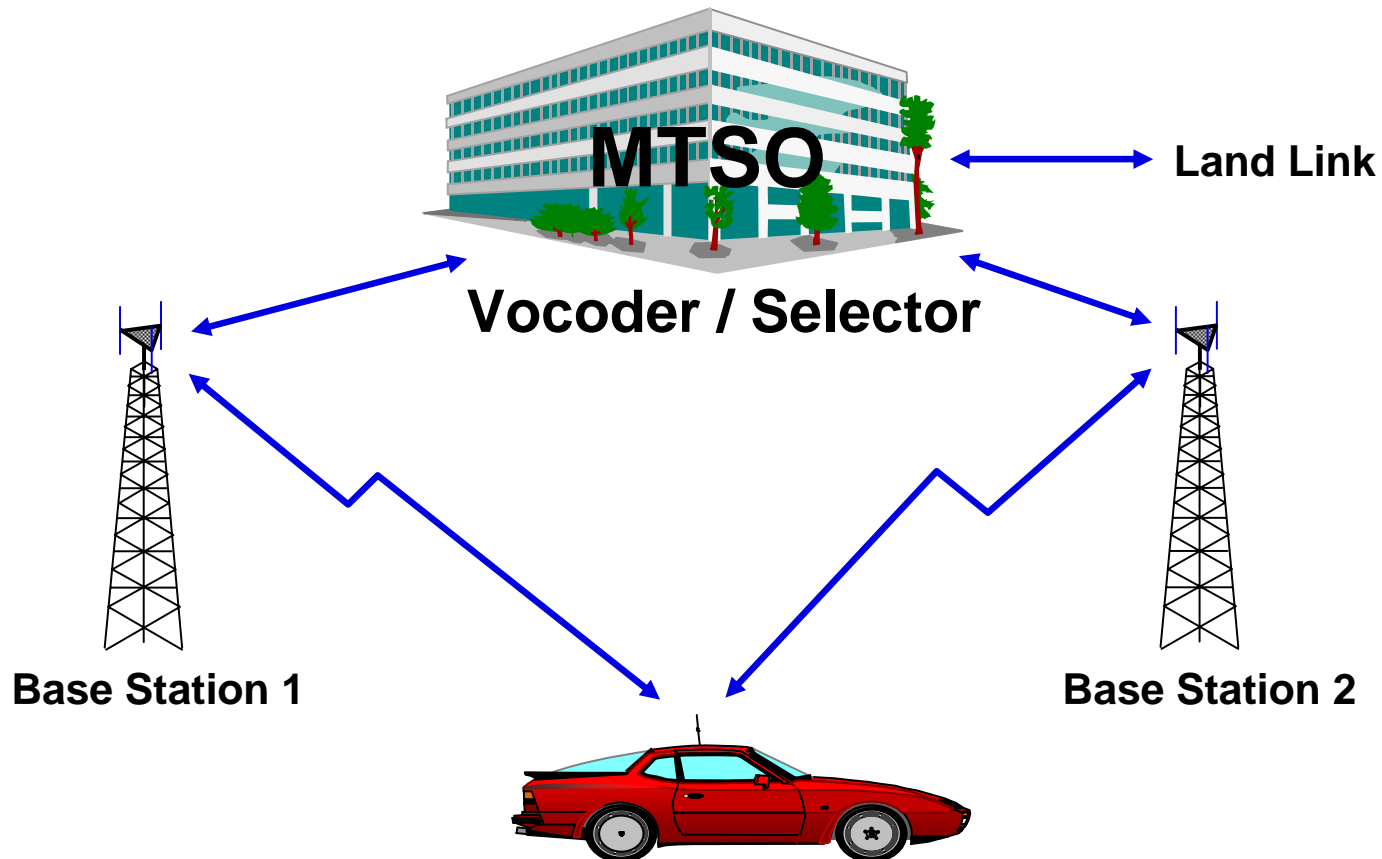

CDMA Frequency Diversity

- Combats Fading, Caused by Multipath
- Fading Acts like Notch Filter to a Wide Spectrum Signal
- May Notch only Part of Signal

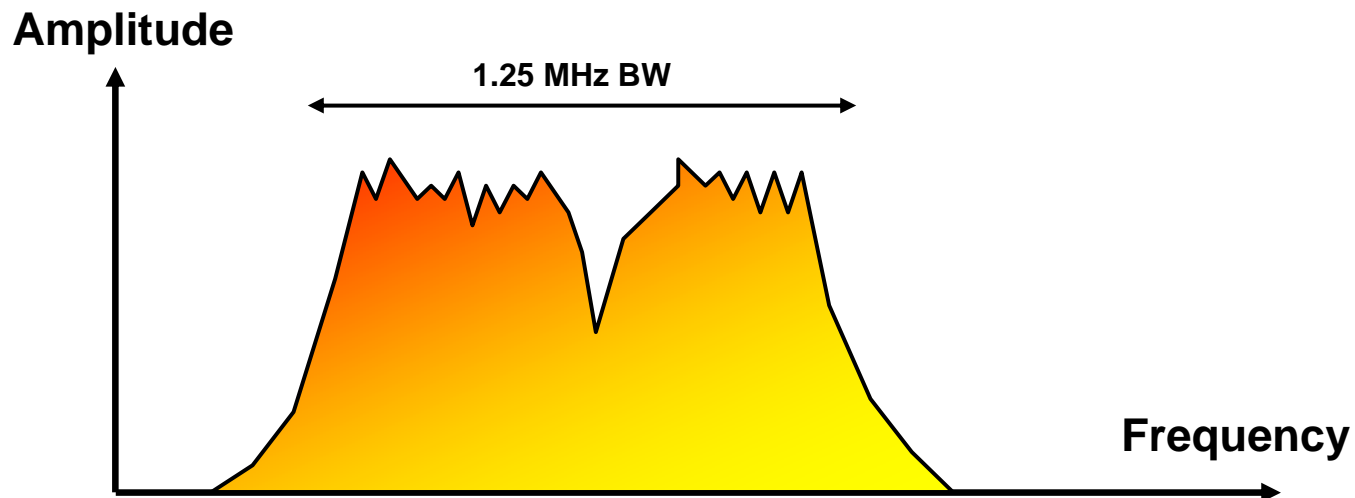

CDMA Time Diversity

- Uses Rake Receiver
- Convolutional Encoding
- Data is Interleaved
- Viterbi Decoding

The Rake Receiver

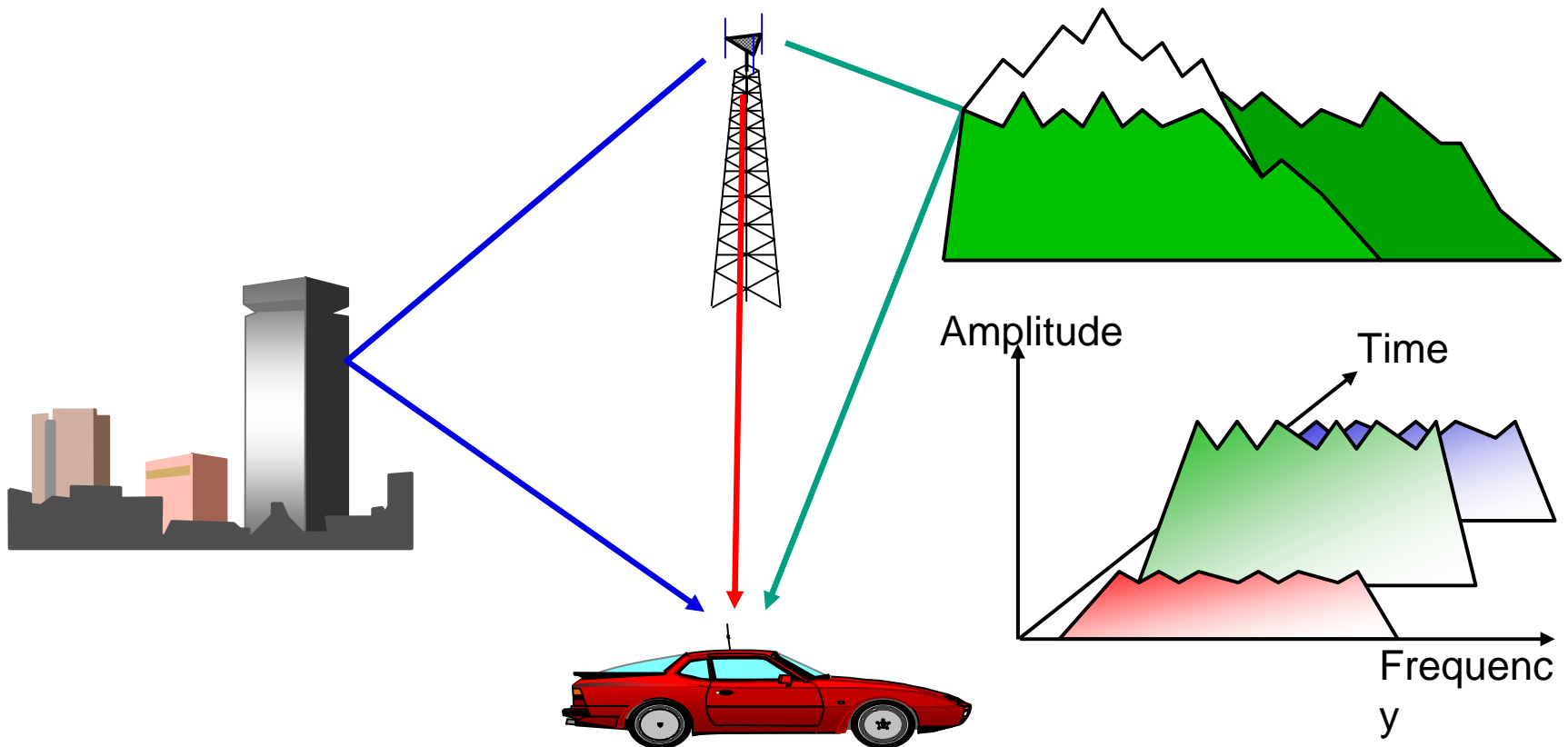

Power Control

- Important in cdma systems because of frequency reuse of $N=1$
- The goal is to maintain equal received power at the base station from each mobile
- Affects traffic channels (not pilot signal)

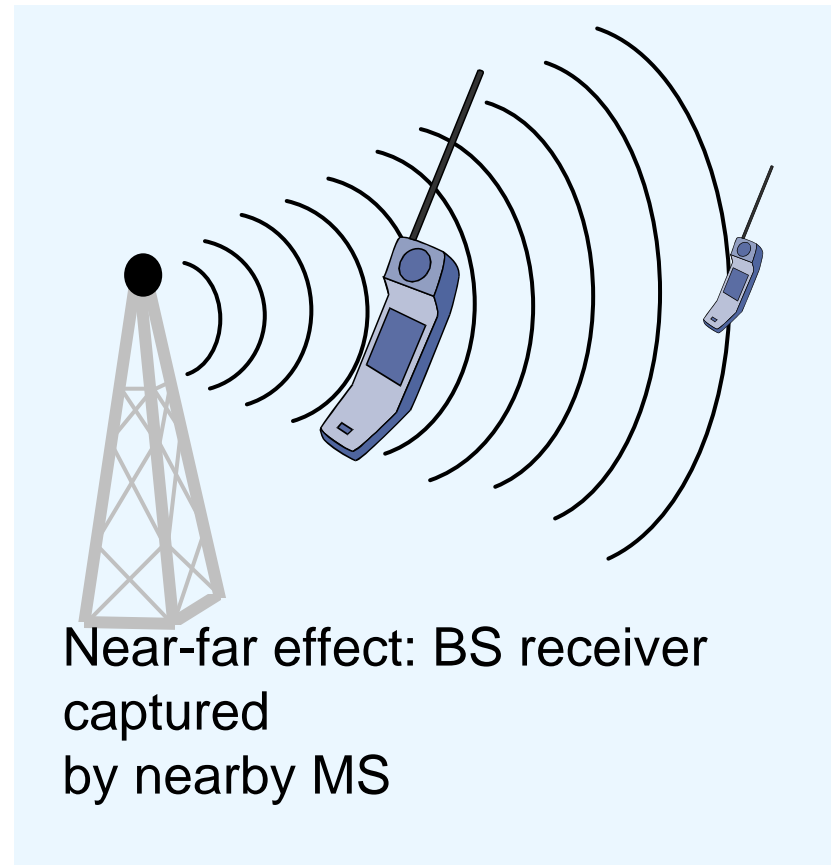

CDMA Power Control

(Reverse Link)

- All Mobiles are Received at Base Station at Equal Power
- Two Types of Control
 - Open Loop Power Control
 - Closed Loop Power Control

Open Loop Power Control

(Reverse Link)

- Assumes Loss is Similar on Forward and Reverse Paths.
- Receive Power + Transmit Power = -73
 - All powers in dBm
- Example:
 - For a Received Power of -85 dBm (at the mobile)

$$\text{Transmit Power} = (-73) - (-85)$$

$$\text{Transmit Power} = +12 \text{ dBm}$$

Closed Loop Power Control

(Forward & Reverse)

- Directed by Base Station (for the Reverse Link) and by Mobile (for the Forward Link)
- Updated Every 1.25 msec
- 1 dB Step Size (also 0.25 and 0.5 dB)
- Closed Loop Adds to Open Loop Power Estimate on Reverse Link

Forward Link Traffic Channel IS-95 Physical Layer

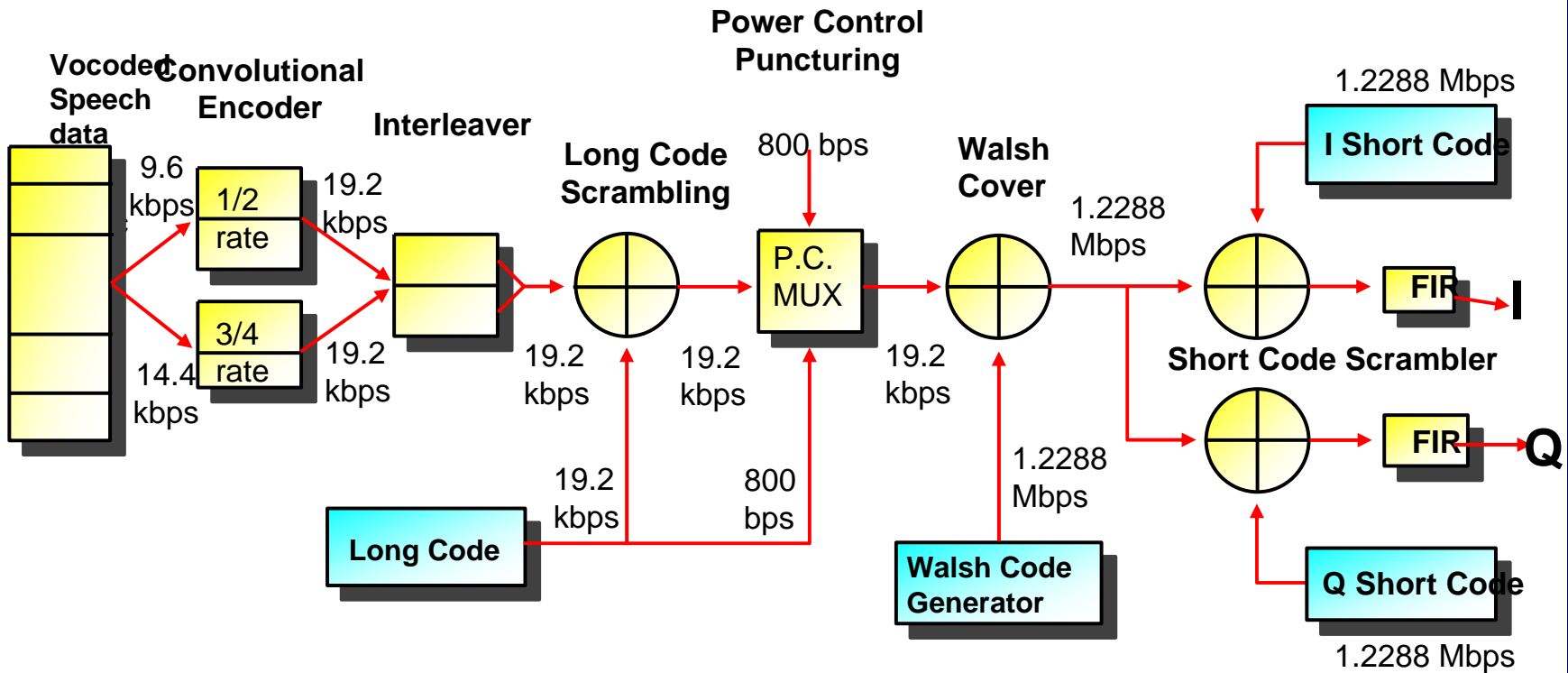

Code Domain Power (IS-95)

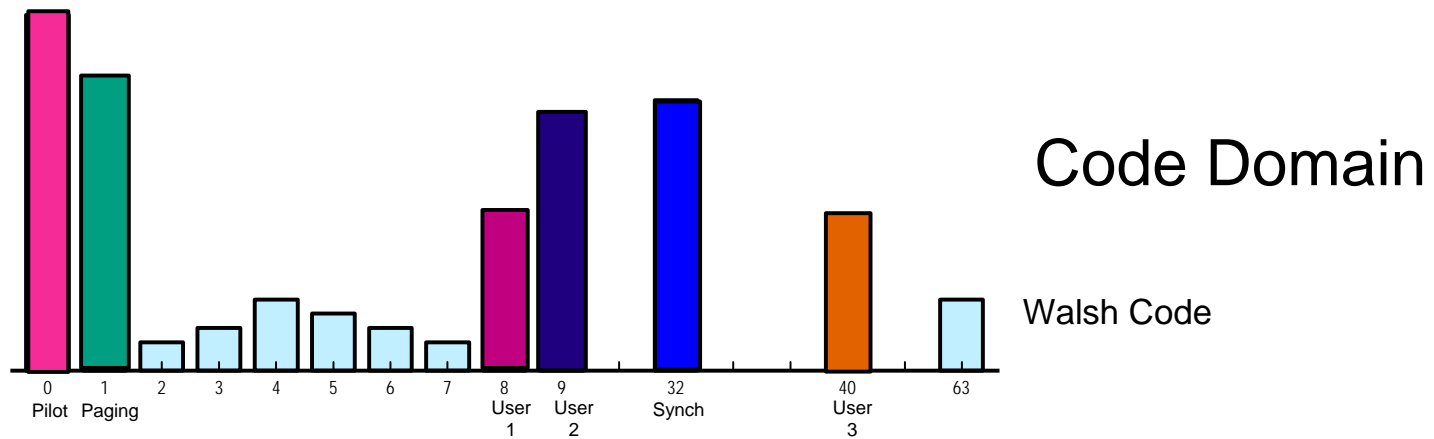
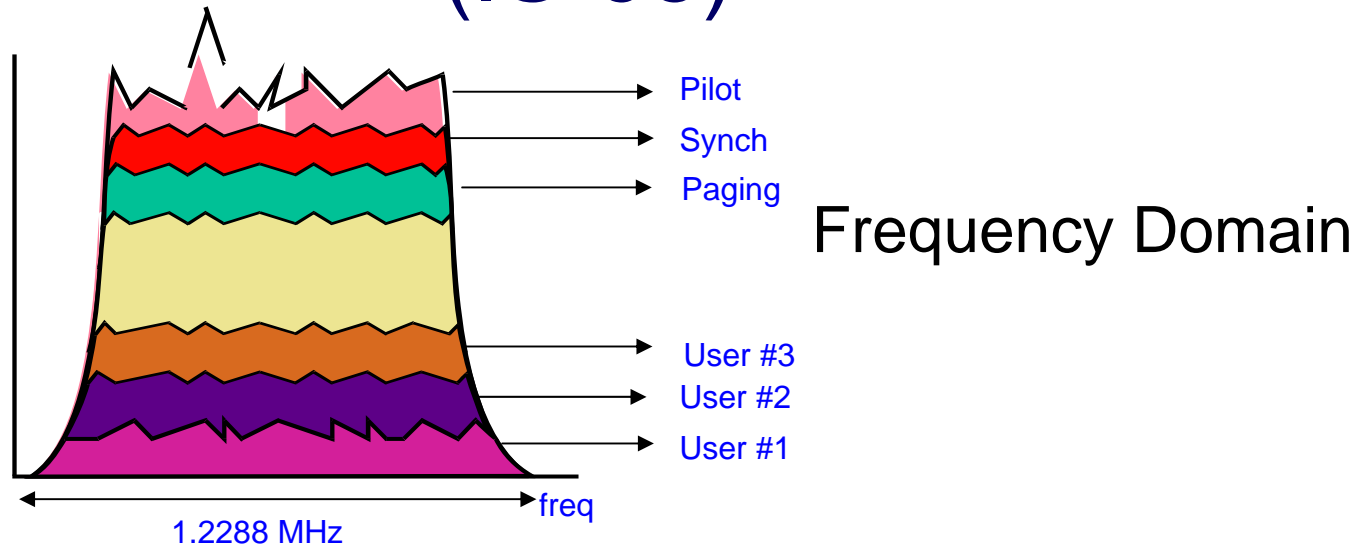

Contents

- **Review of IS-95 CDMA Concepts**
- **cdma2000 Improvements**
- **cdma2000 Concepts**
- **cdma2000 Network Architecture**

IS-2000 Improvements vs. IS-95

- **2X Voice Capacity**
 - Reverse Link Pilot for Each Mobile
 - Fast Forward (new) and Reverse Link Power Control
- **QPSK Modulation**
- **Improved Convolutional Channel Encoding for 14.4 kbps Voice Channels**
- **Supports Auxiliary Pilots for Beam Forming, Multi-Antennas, and many other options**

cdmaOne to cdma2000 1xRTT

- **1xRTT keeps same chip rate and carrier bandwidth**
- **Splits the data into I and Q (QPSK Modulation vs. P-BPSK)**
- **Keep existing IS-95-based channels for backwards compatibility with IS-95 mobiles**
 - IS-95B enhancements retained
- **Adds new radio configurations, adds new FWD and REV channels**
 - New optional control channels
 - New fundamental traffic channels
 - New supplemental traffic channels for faster data
 - New turbo codes and spreading techniques
- **~35 max users/sector/carrier for IS-95, ~70 max for IS-2000**

cdma2000 to Achieve 3G Data Rates (cont.)

- New transmission modes offer faster data rates

Technology	Data Capabilities
IS-95A/J-Std008	Up to 14.4 kbps using one traffic channel for supplemental data
IS-95B	Up to 115.2 kbps using 1 traffic channel and up to 7 supplemental code channels supporting 14.4 kbps each
1xRTT	Up to 153.6 kbps (RC3) or 307.2 kbps (RC4) per SCH (one deployed today); RC3 avail. today; Uses fundamental & supplemental channels, advanced rate and QoS management
3xRTT	Up to 1.0386 Mbps (RC9) using fundamental channel for voice and supplemental channel(s) for data; 2 Mbps using 2 SCH

- 1xEV-DO and 1xEV-DV: 2.4 Mbps and higher

The CDMA Technology Path to 3G

	cdmaOne			cdma2000/IS-2000		
Generation	1G	2G	2G	2.5G or 3	3G	3G
Technology	AMPS	IS-95A/J-Std008	IS-95B	IS-2000: 1xRTT	IS-2000: 3xRTT	1xEV-DO/DV
Signal Bandwidth, #Users	30 kHz. 1	1250 kHz. 20-35	1250 kHz. 25-40	1250 kHz. 50-80 voice and data	F: 3x 1250k R: 3687k 120-210 per 3 carriers	1250 kHz. Many packet users
Data Capabilities	None, 2.4K by modem	14.4K	64K	153K 307K 230K	2.0 Mb/s	2.4 Mb/s (1xEV-DO) 3.864 Mb/s (1xEV-DV)
Features: Incremental Progress	First System, Capacity & Handoffs	First cdma, Capacity, Quality	<ul style="list-style-type: none"> •Improved Access •Smarter Handoffs 	<ul style="list-style-type: none"> •Enhanced Access •Channel Structure 	Faster data rates on shared 3-carrier bundle	Faster data rates on 1x carrier

Differences Between W-CDMA and cdma2000

W-CDMA	cdma2000
New Spectrum only	Overlay IS-95
3.84 Mcps	1.2288 Mcps
New equipment	Upgrade existing

3GPP

3GPP2

Contents

- Review of IS-95 CDMA Concepts
- cdma2000 Improvements
- **cdma2000 Concepts**
- cdma2000 Network Architecture

IS-95A/B (9.6 kbps)

Traffic Channel (F-FCH)

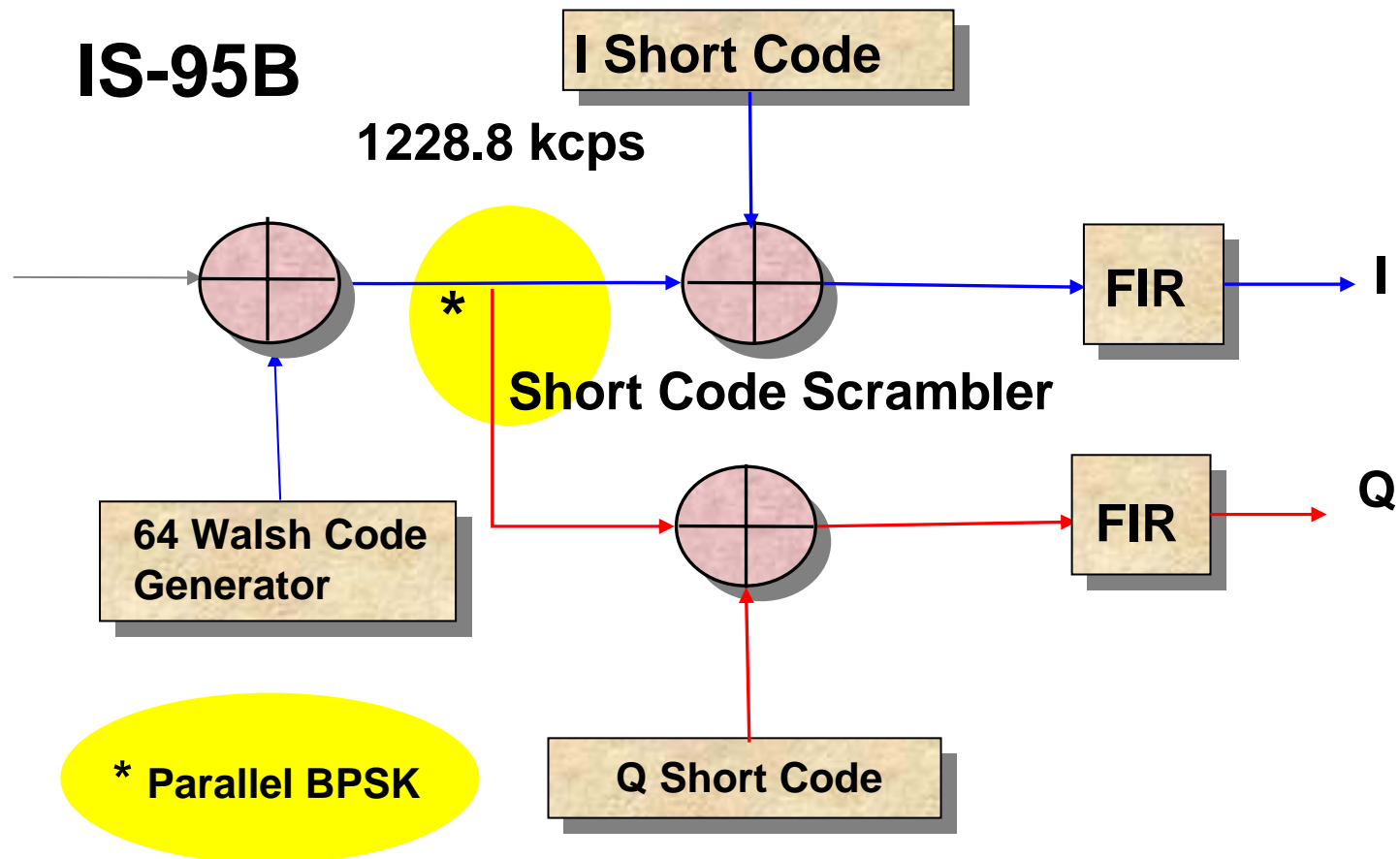

IS-2000 SR1, RC3 (9.6 kbps)

(cont.)

Traffic Channel (F-FCH)

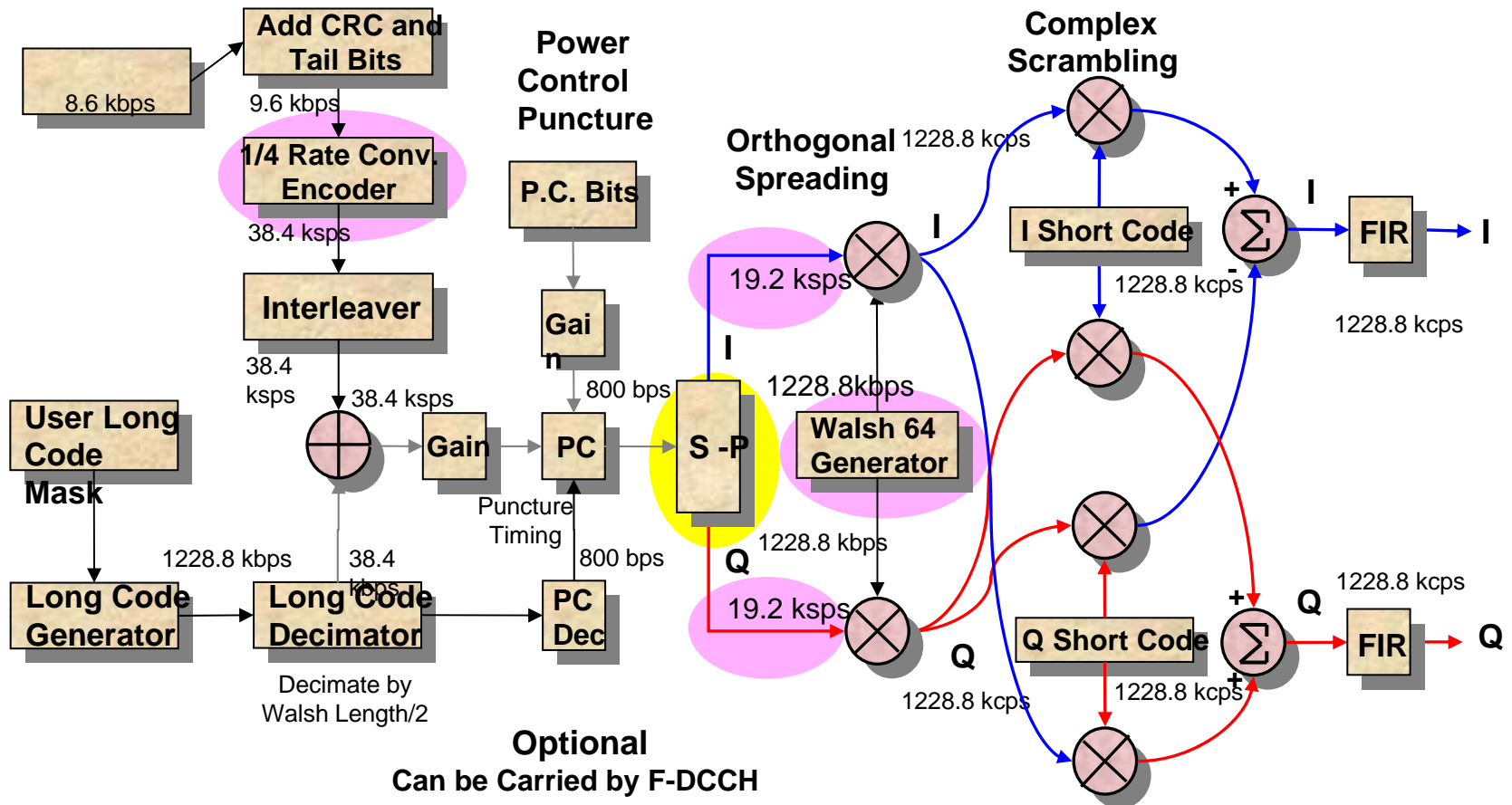

Forward Common Pilot

- Equivalent to IS-95 pilot (Walsh 0 with chip offsets identifying BSs)
- 512 total PN's with 64-chip offsets
- Provides synchronism, signal measurements and phase reference
- Pilot, Paging, Sync applied only to in-phase channel

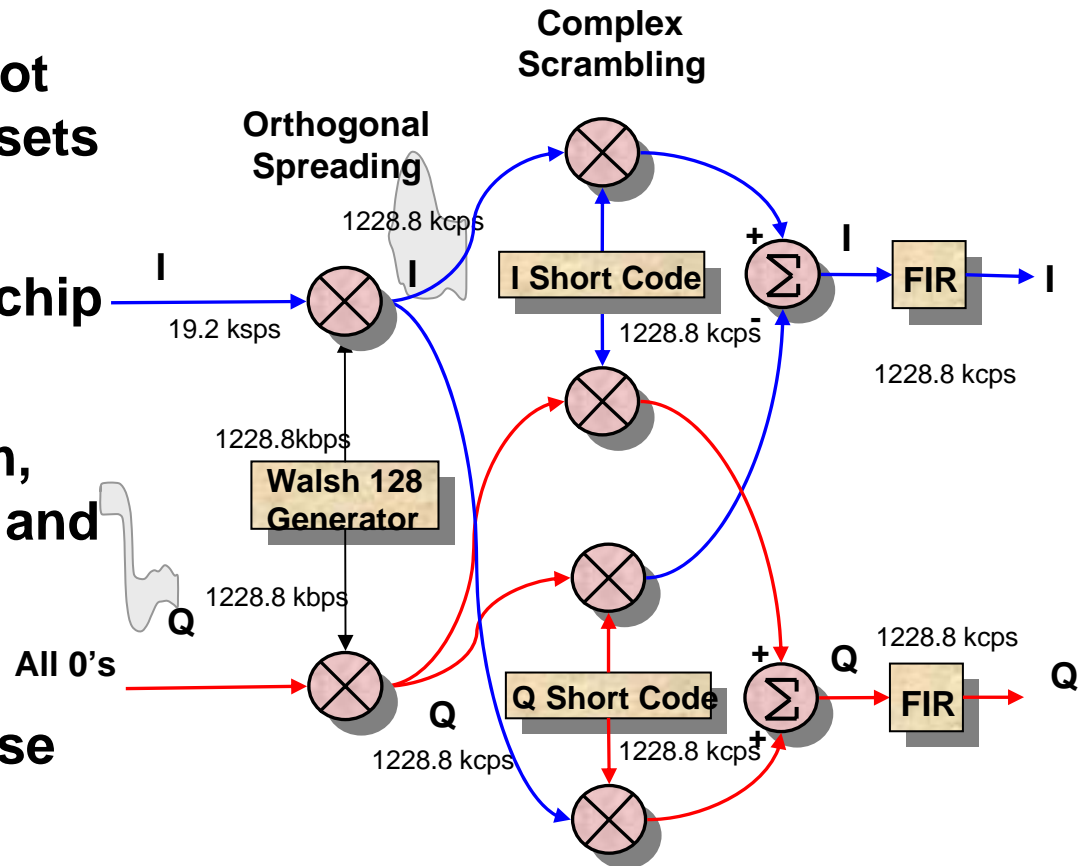

Creating a Walsh Code Matrix

$$W_1 = [0] \quad W_2 = \begin{bmatrix} W_1 & W_1 \\ W_1 & \overline{W_1} \end{bmatrix} \quad W_4 = \begin{bmatrix} W_2 & W_2 \\ W_2 & \overline{W_2} \end{bmatrix} \quad \dots \quad W_{2n} = \begin{bmatrix} W_n & W_n \\ W_n & \overline{W_n} \end{bmatrix}$$

Example

W_1	W_2	W_4	W_8
0	00	0000	00000000
	0 <u>1</u>	0101	01010101
		00 <u>11</u>	00110011
		01 <u>10</u>	01100110
			0000 <u>1111</u>
			0101 <u>1010</u>
			0011 <u>1100</u>
			0110 <u>1001</u>

Referencing Walsh Codes

$$W_4[2] = 0011$$

$$W_8[7] = 01101001$$

$$W_2[0] = 00$$

$$W_7^8 = \text{Walsh Set 8} \\ \text{Walsh Code 7}$$

IS-2000 Walsh Code Tree

Hadamard Sequence

Walsh 2	Walsh 4	Walsh 8
0 1 1	0 1 1 1 1	0 1 1 1 1 1 1 1
1 1 -1	1 1 -1 1 -1	1 1 -1 1 -1 1 -1
2 1 1 -1 -1	2 1 1 -1 -1	2 1 1 -1 -1 1 1 -1 -1
3 1 -1 -1 1	3 1 -1 -1 1	3 1 -1 -1 1 1 -1 -1
		4 1 1 1 1 -1 -1 -1
		5 1 -1 1 -1 -1 1 -1
		6 1 1 -1 -1 -1 -1 1
		7 1 -1 -1 1 -1 1 1 -1

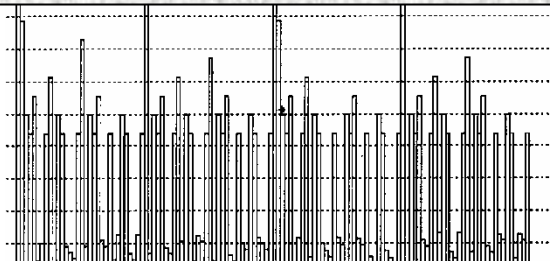

Bit Reversed Sequence

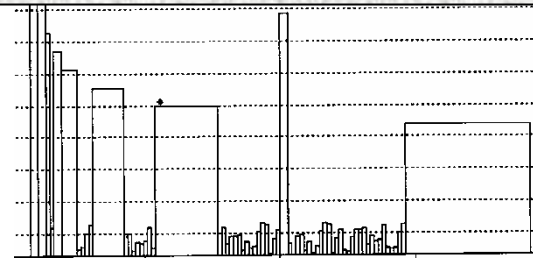
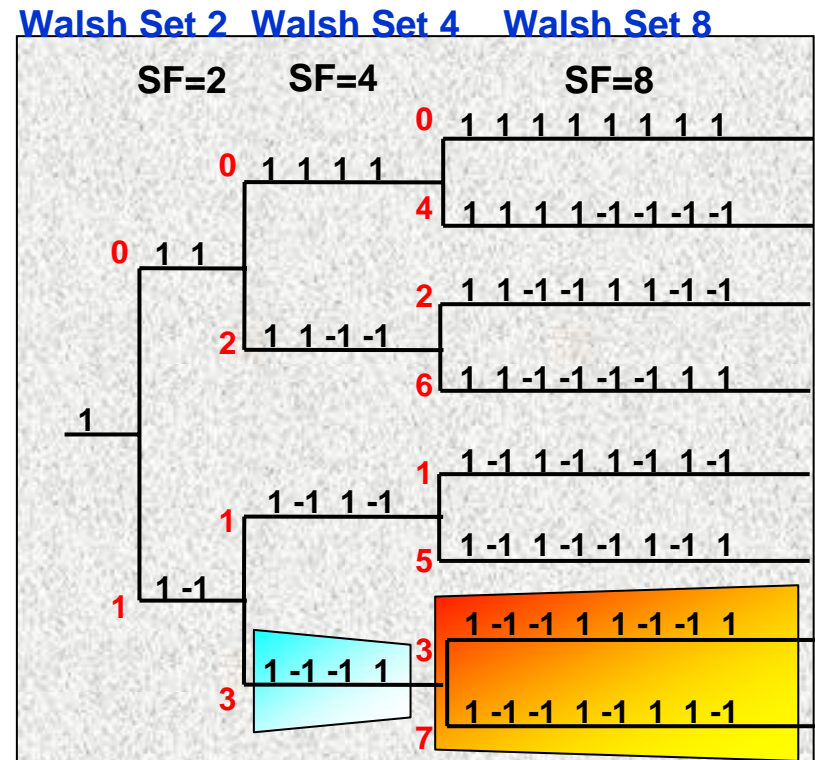

Effects of Using Variable Length Walsh Codes

- Logical 1's and 0's can be represented as physical -1's and 1's in the modulation domain

- Shorter Codes on a Branch map into Longer Codes

- Using Shorter Walsh Codes Precludes Using all Longer Codes Derived from the Original

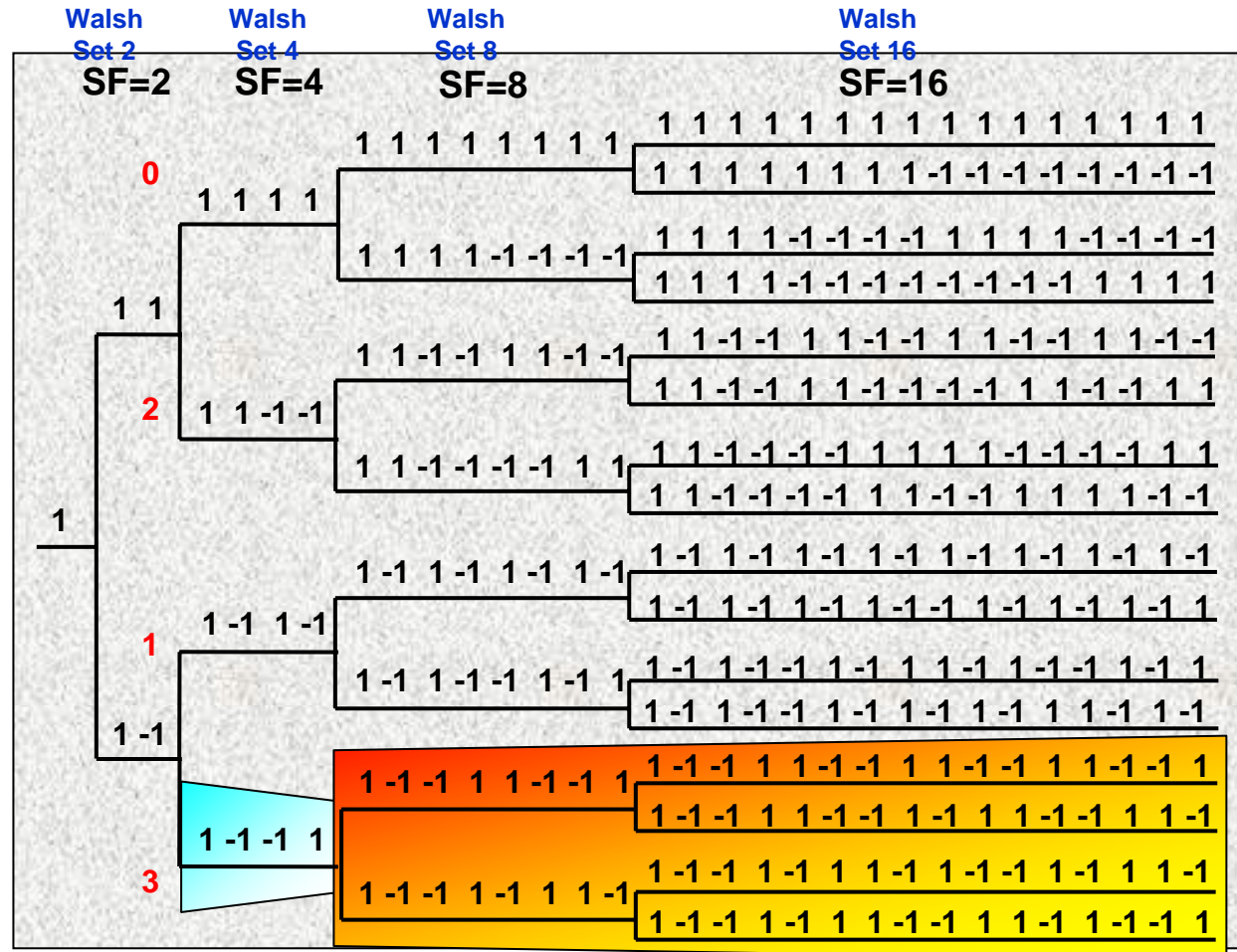

Orthogonality of Walsh Codes

- Walsh codes are:
 - Orthogonal with each other and their inverses:
 - *Orthogonality = Equal Number of Matches and Mismatches*

Walsh Codes with SF=8

Code	1	1	1	1	1	1	1
Code	1	-1	-1	1	1	-1	-1

1

Match? Y N N Y Y N N

Y

Matches	=
4	
Mismatches	= 4

Net Correlation = 0

IS-2000 Walsh Code Tree (Top Half)

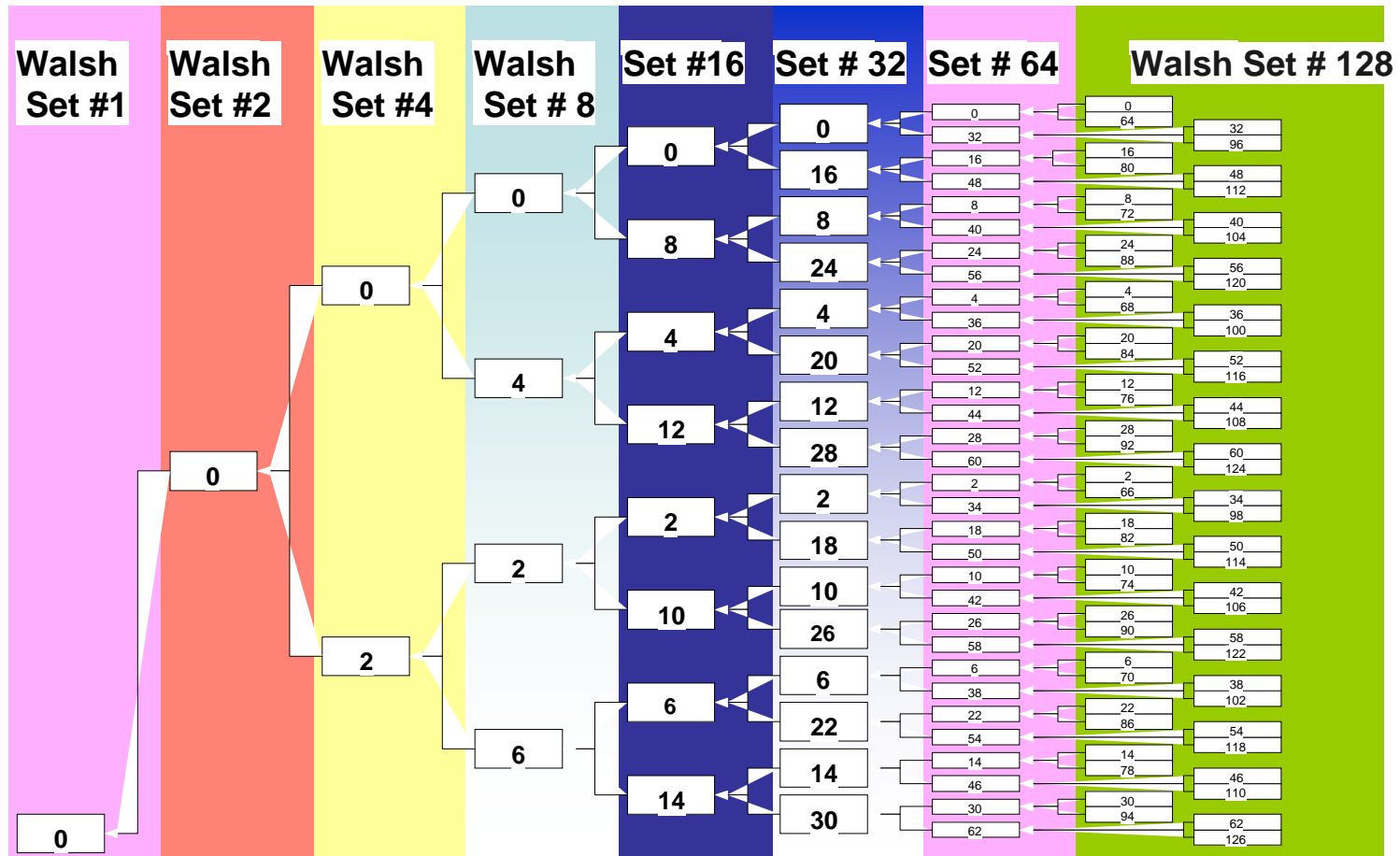

IS-2000 Forward Radio Configurations

- **Radio Configuration 1 - Required**
 - Backwards compatible mode with TIA/EIA-95-B
 - Based on 9,600 bps Traffic
- **Radio Configuration 2**
 - Backwards compatible mode with TIA/EIA-95-B
 - Based on 14,400 bps Traffic
- **Radio Configurations 3, 4, and 5**
 - All use new IS-2000 coding for improved capacity
 - RC3 is based on 9,600 bps and goes up to 153,600 bps
 - RC4 is based on 9,600 bps and goes up to 307,200 bps
 - RC5 is based on 14,400 bps and goes up to 230,400 bps

Data Rates & Radio Configurations

Spreading Rate	Radio Configuration	Forward Link	Data Rates	Radio Configuration	Reverse Link	Data Rates	
1 carrier 1.2288 MCPS	RC1	Required. IS-95B Compatible No cdma2000 coding features	9600 variable	RC1	Required. IS-95B Compatible No cdma2000 coding features	9600 variable	
	RC2	Compatible with IS-95B RS2 No cdma2000 coding features	14400 variable	RC2	Compatible with IS-95B RS2 No cdma2000 coding features	14400 variable	
	RC3	Quarter-rate convolutional or Turbo Coding, base rate 9600	9600 153600	RC3	1/4 rate conv or Turbo coding, 96 1/2 rate conv or Turbo coding, 96	9600 153600	
	RC4	Half-rate convolutional or Turbo Coding, base rate 9600	9600 307200			307200	
		RC5	3/8 rate convolutional or Turbo Coding, base rate 14400	14400 230400	RC4	1/4 rate convolutional or Turbo Coding, base rate 14400	14400 230400
3.6864 MCPS as 3 carriers 1.2288 MCPS	RC6	1/6 rate convolutional or Turbo coding, base rate 9600	9600 307200	RC5	Required. 1/4 or 1/3 convolutional Or Turbo coding, base rate 9600	9600 307200	
	RC7	Required. 1/3 rate convolution or Turbo coding, base rate 9600	9600 614400			614400	
		RC8	1/4 or 1/3 rate convolutional or Turbo coding, base rate 14400	14400 460800	RC6	1/4 or 1/2 convolutional or Turbo encoding	14400 460800
		RC9	1/2 or 1/3 rate convolutional or Turbo encoder, base rate 14400	14400 1036800			1036800

2G Today: IS-95 CDMA Channels

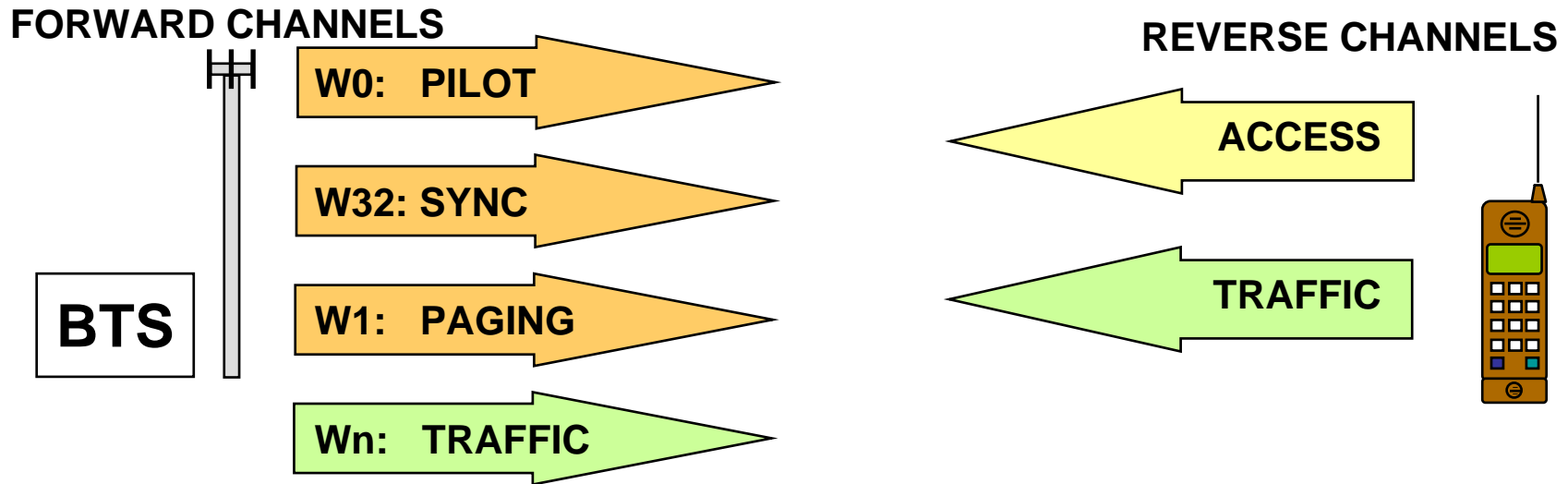

- Existing IS-95A/JStd-008 cdma offers one physical structure using just the channels shown above
- IS-2000 cdma is backward-compatible with this IS-95, but offers additional radio configurations with additional channels

cdma2000 Channels

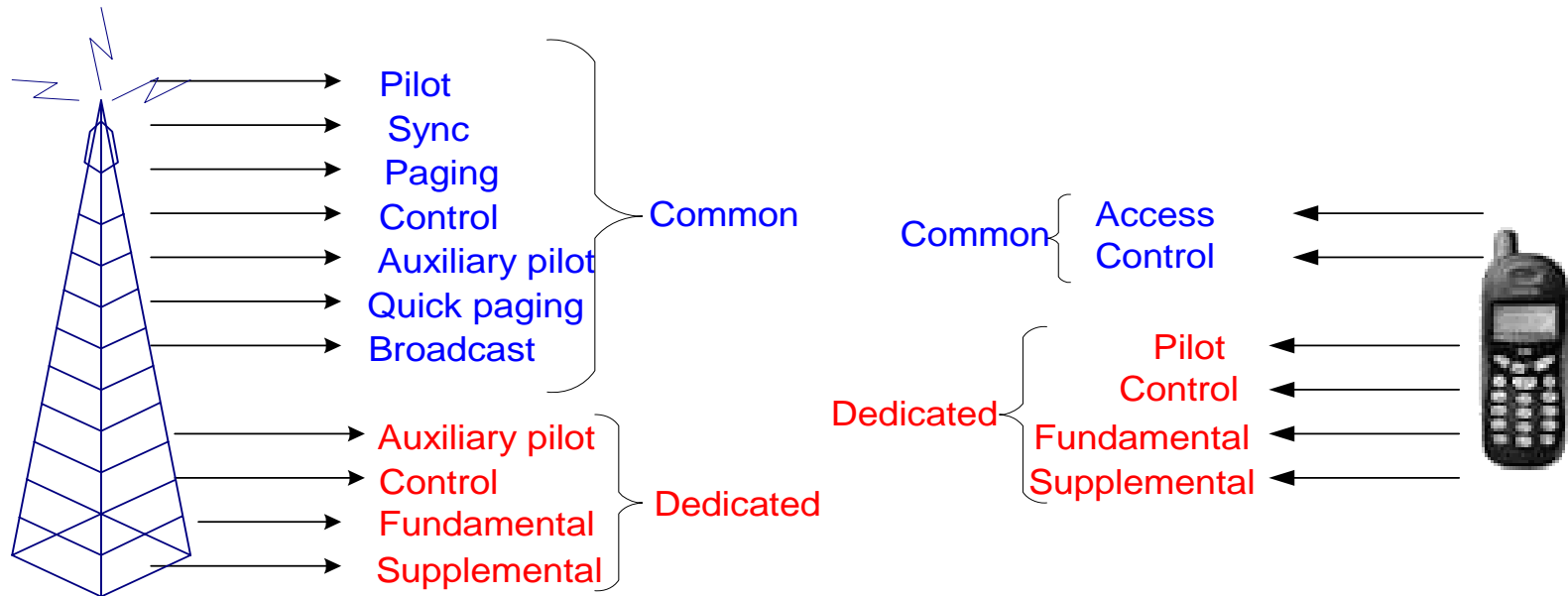

- Dedicated: Point-to-point, single BS → single MS
- Common: Shared information for/from multiple MS

cdma2000 SR1 CDMA Channels

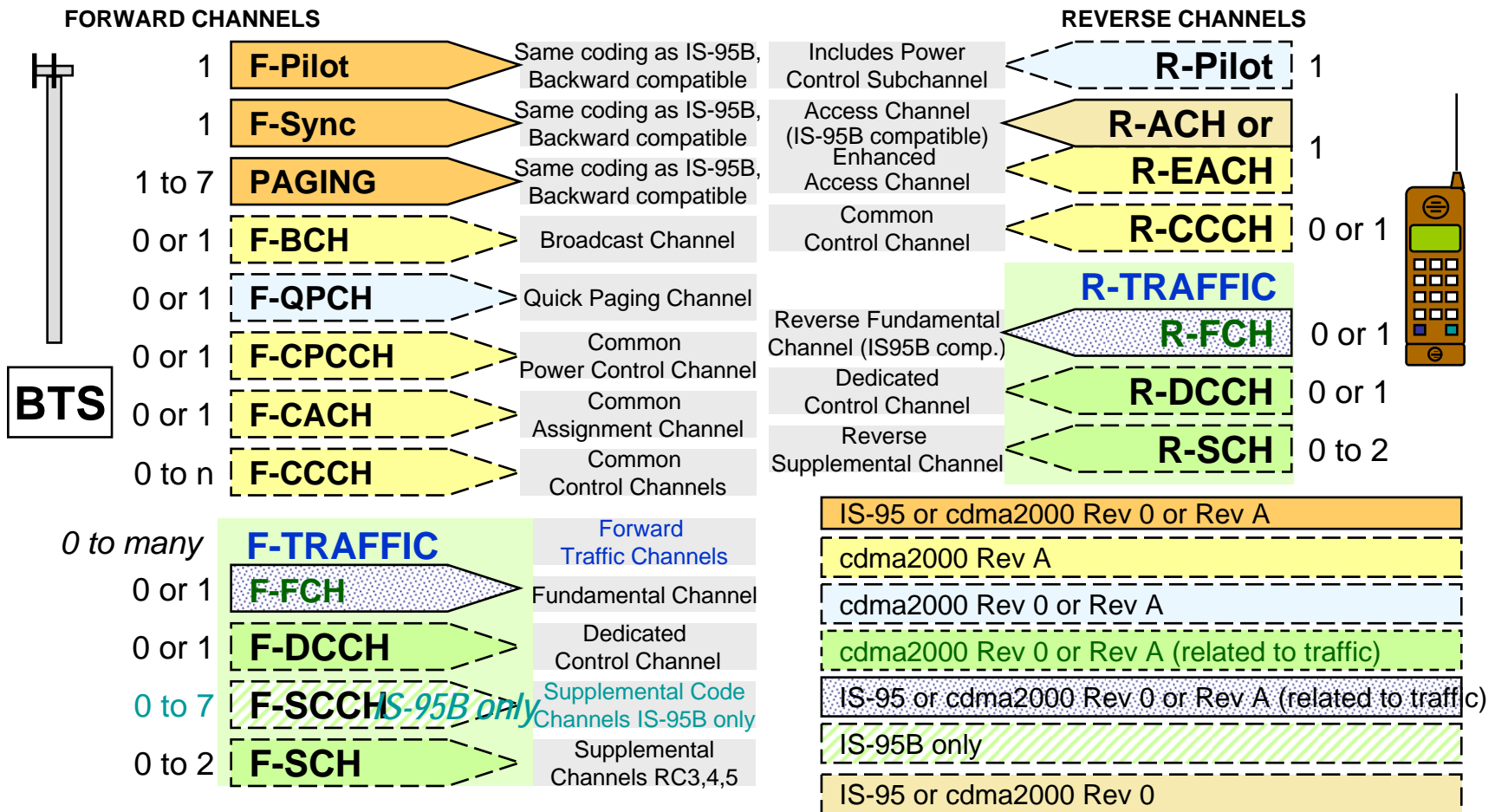

Contents

- **Review of IS-95 CDMA Concepts**
- **cdma2000 Improvements**
- **cdma2000 Concepts**
- **cdma2000 Network Architecture**

Existing CDMA Voice Networks

- **The cdma voice conversation's 20-ms frames are carried as packets between mobile and the Selector**
 - The selector assembles frames being sent to the mobile and disassembles frames coming from the mobile
 - Frame contents normally include voice and occasional signaling; may also include data if additional equipment is included (not shown)
- **The vocoders in the BSC and the mobile convert the packet stream into continuous DS-0 audio for the end-users**
 - The MSC makes a circuit-switched connection for call

Existing CDMA Voice Networks (cont.)

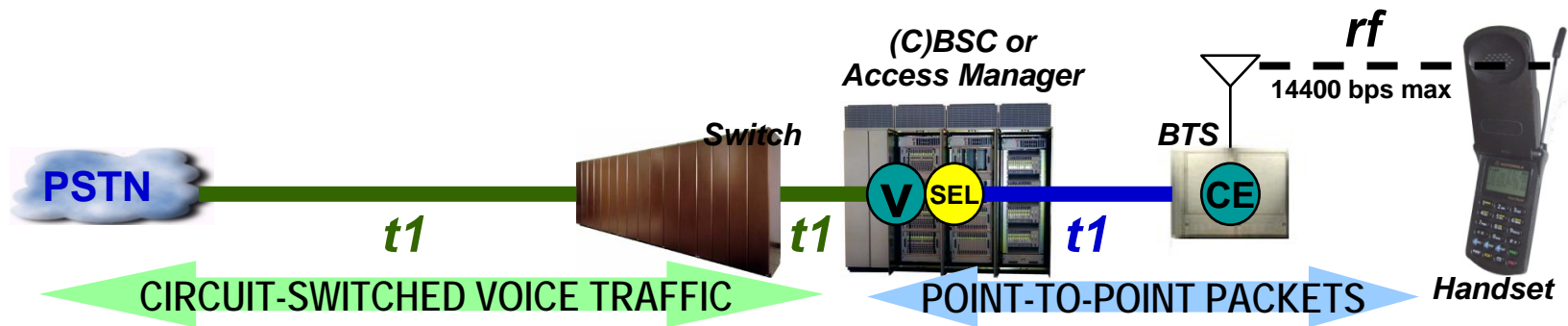

2nd Generation cdma Networks were designed primarily to handle voice

Data Capability Today on a CDMA Network

- **Data to/from the user connects near the selector in the BSC**
 - Passed through the switch as 56kb/s data links in 64kb/s DS-0s
- **Data connection to outside world handled by IWF InterWorking Function**
 - Includes modems to convert data stream into DS-0 for dial-up uses
 - Can contain data routers to access IP or PPP networks
 - May include capability for FAX and other communications modes

Data Capability Today on a CDMA Network (cont.)

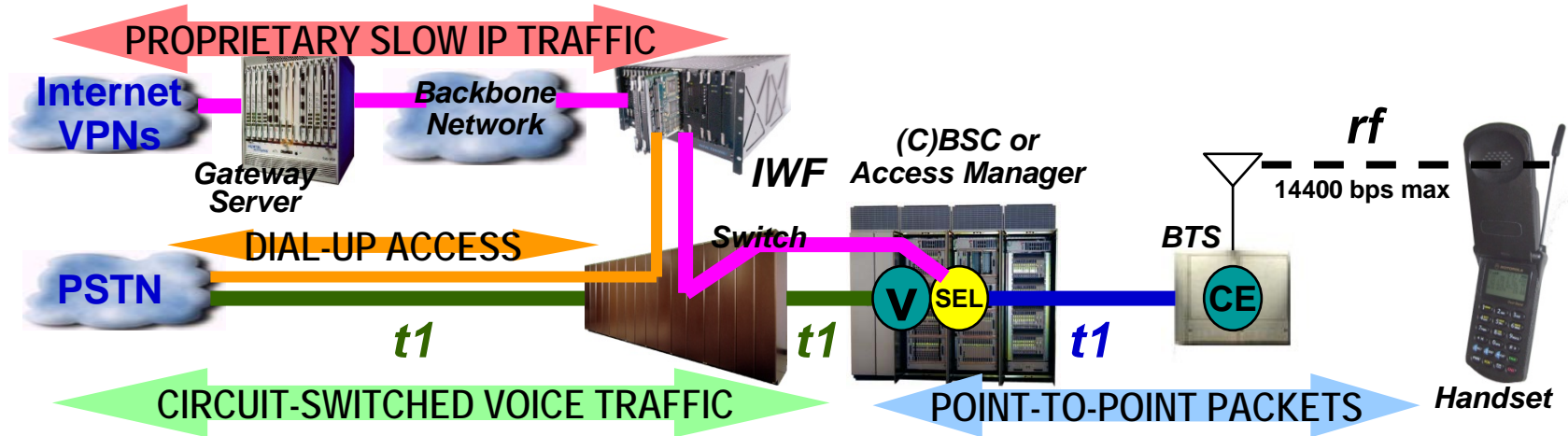

Additional hardware was needed to carry data on a 2G network

cdma2000 Network

Packet Data Requires New H/W including PCF and PDSN

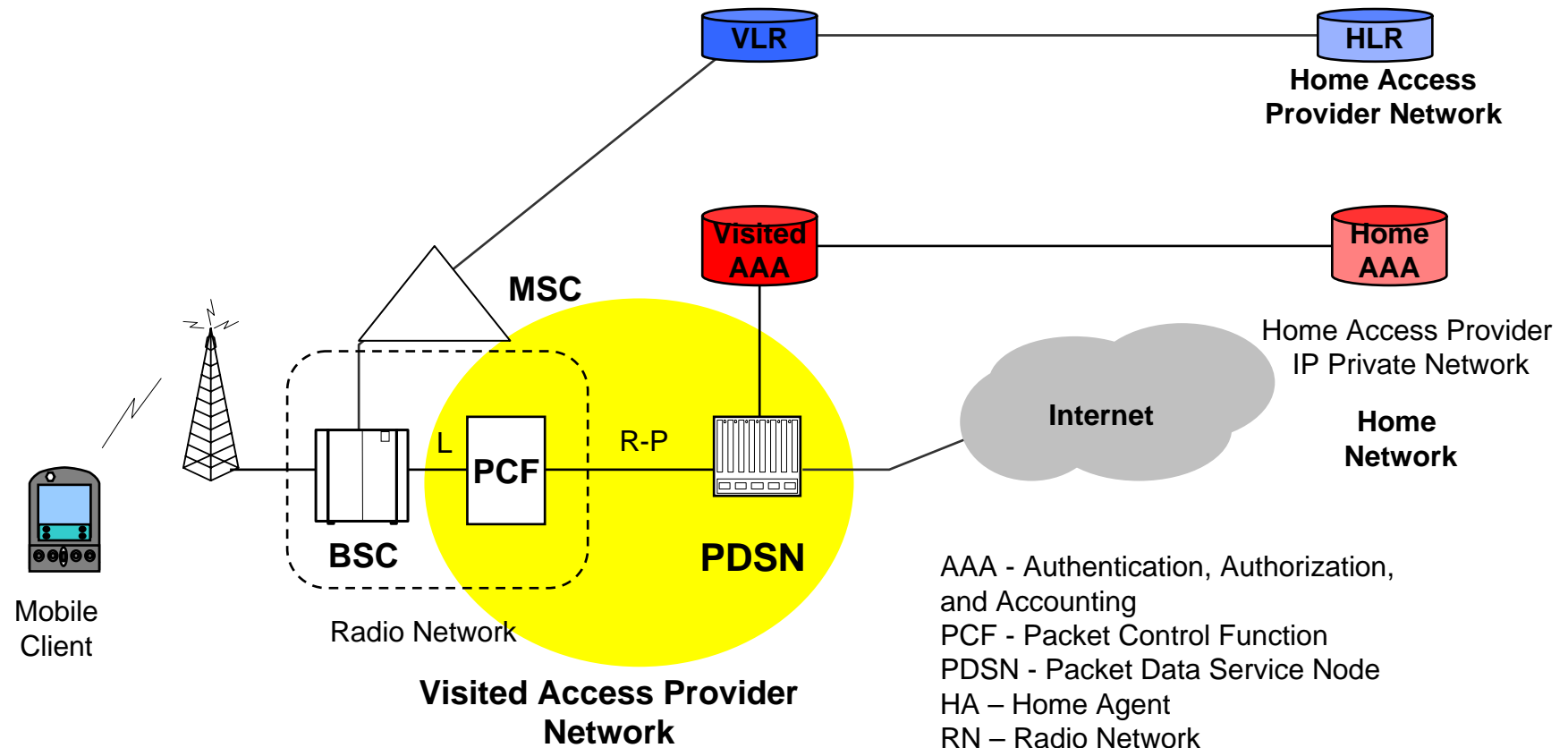

3G Data Capabilities: 1xRTT CDMA Network

- **This requires a Packet Data Serving Node**
 - ISP and operator-provided services are provided by external Home Network and Home Agent servers
 - Authentication, Authorization, and Accounting provided by external server
- **The IWF (InterWorking Function) is still maintained to allow old mobiles to use dial-up and WAP/wireless web keypad access**

3G Data Capabilities: 1xRTT CDMA Network (cont.)

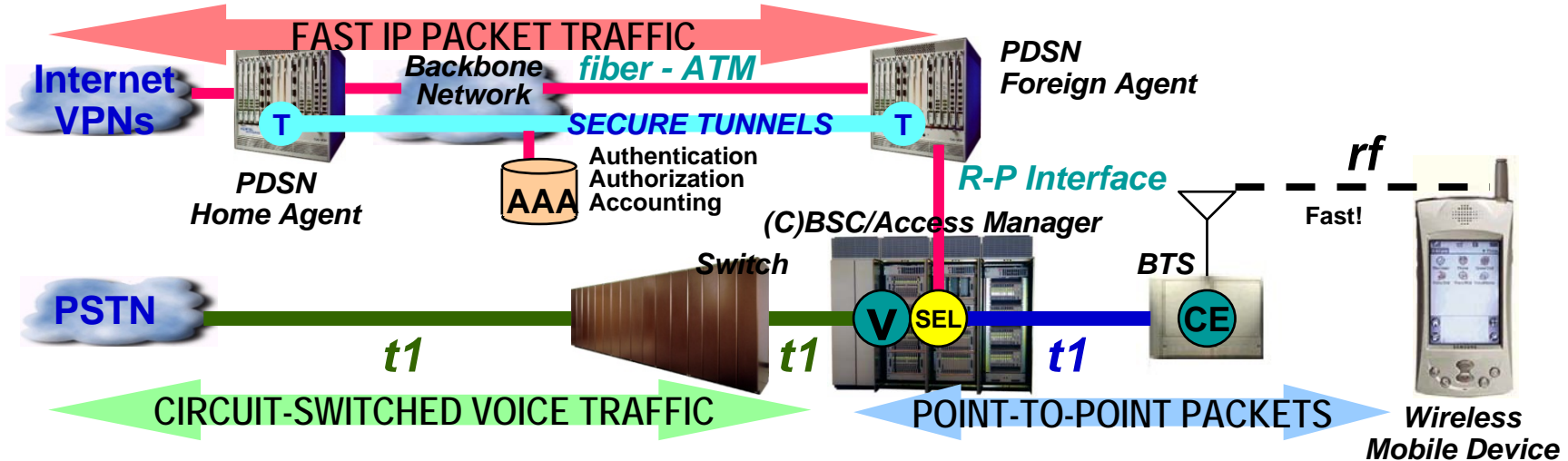

For full-featured data access over a 3G network, a true IP connection must be established to outside Packet Data Networks

Conclusions

- **IS-2000 is Backwards Compatible with TIA/EIA-95-B**
- **Provides 2x Capacity Improvement Over TIA/EIA-95-B**
 - Improved Coding
 - Improved Modulation
 - Coherent Reverse Link Demodulation (Mobile Pilot)
 - Fast Forward Link Power Control
- **Supports High Speed Data for New Applications**

Acknowledgements

- Selected Materials Were Contributed By:
 - *Agilent Technologies Wireless Network Services Division, Wireless Institute of Technology Group, Melbourne, FL*
 - *Scott Baxter and Associates, Nashville, TN*
- **3GPP2 web site: www.3gpp2.org**